

Góra

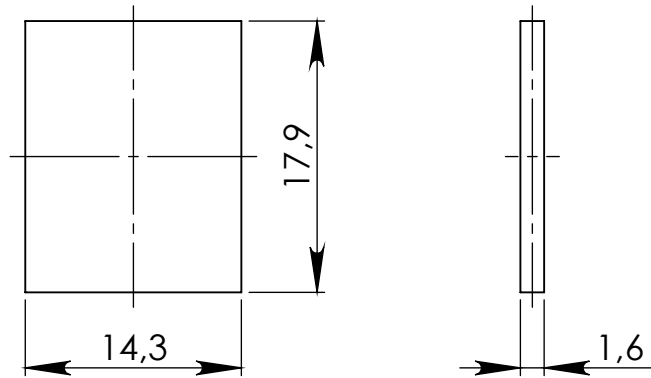

Dół

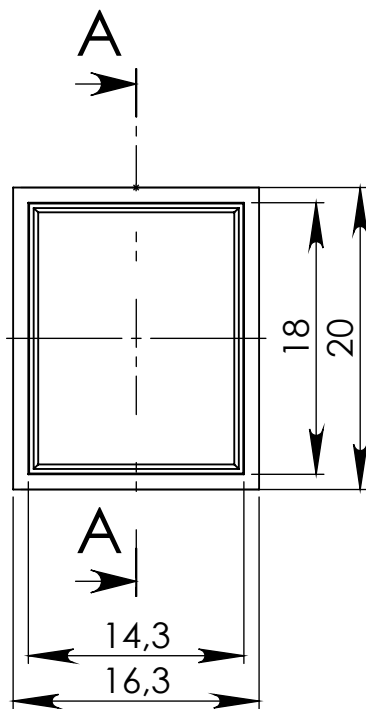

PRZEKRÓJ A-A

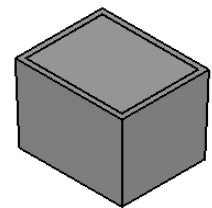
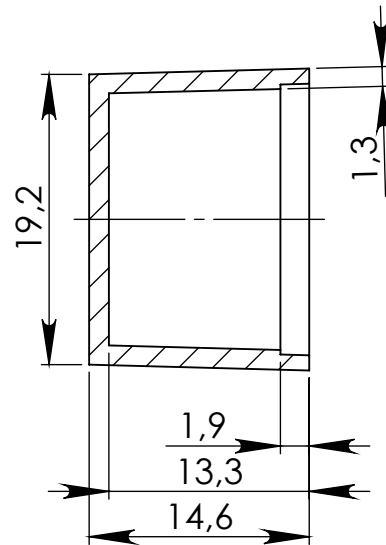

UWAGA: Wymiary w tolerancji $\pm 0,5\text{mm}$

Elementy składowe:
- obudowa góra,
- obudowa dół,

Format	Skala
A4	2:1

Nr produktu
KMz 81



MASZCZYK®

Krzysztof Maszczyk
05-071 Sulejówek-Miłosna
ul. Mickiewicza 10
tel.: (022) 783 45 20, fax.: (022) 783 90 85
kom: 0602 726 086