

Przycisk

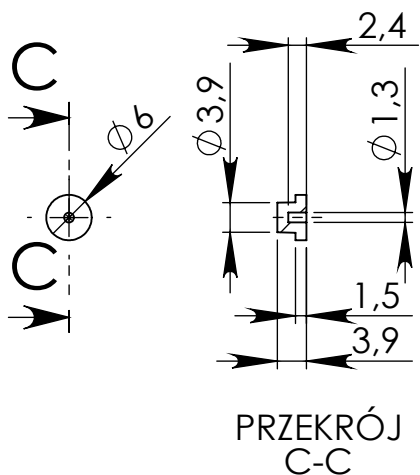

Góra

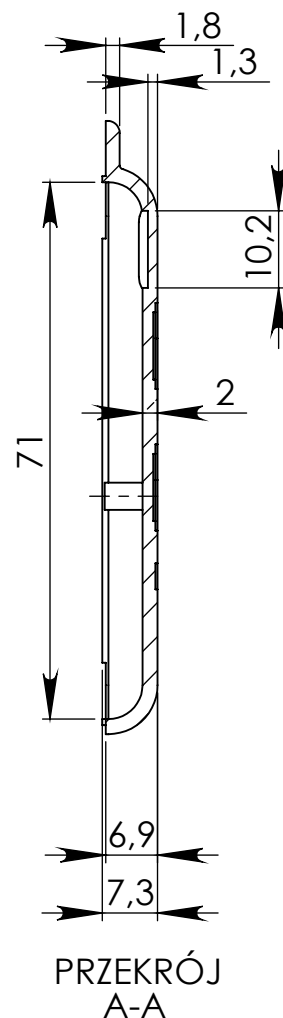
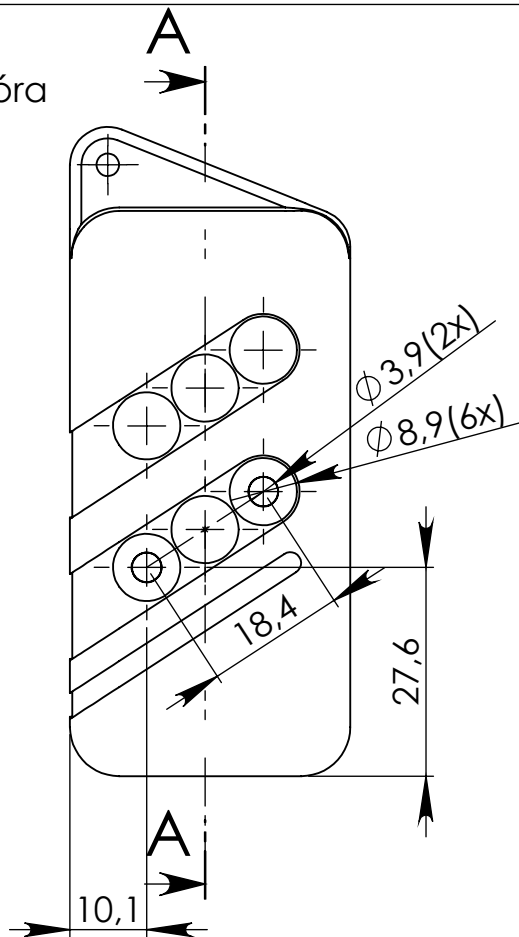

Dół

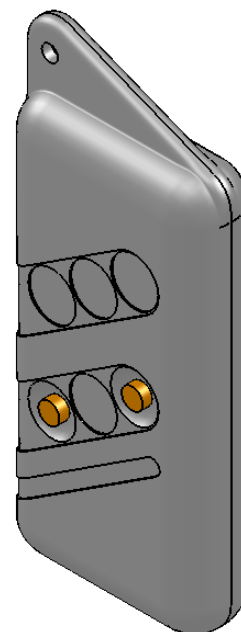
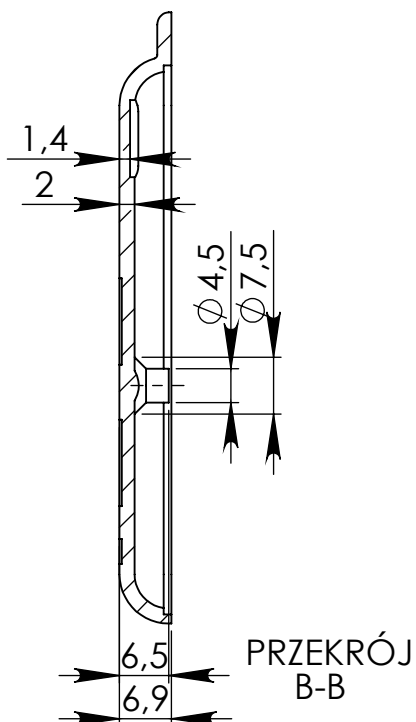
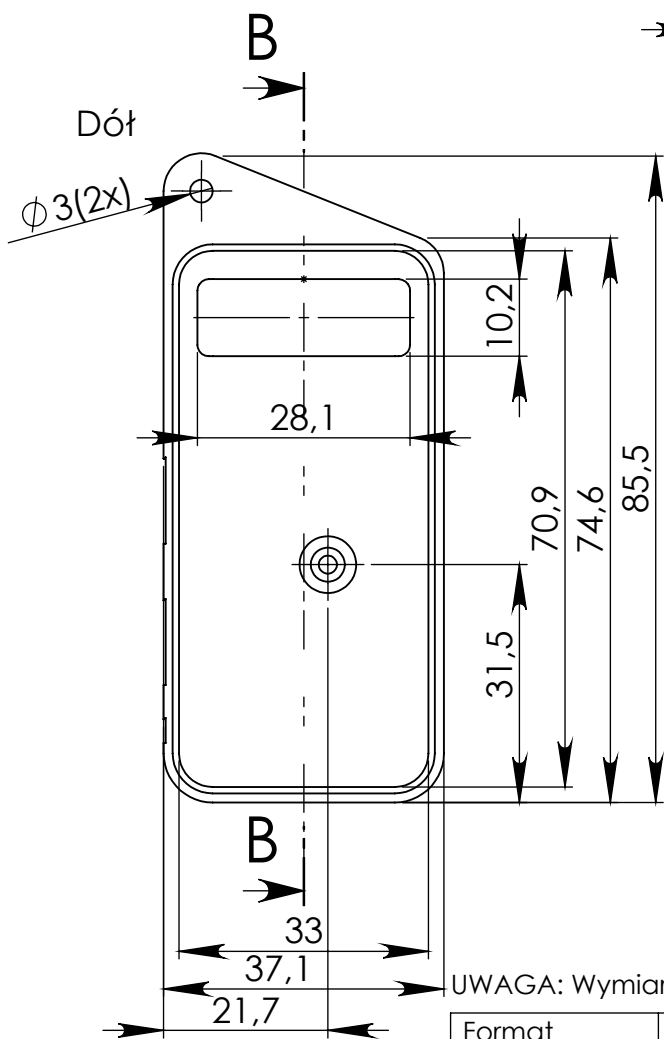

UWAGA: Wymiary w tolerancji $\pm 0,5\text{mm}$

- Elementy składowe:
- obudowa góra,
 - obudowa dół,
 - 2 przyciski,
 - 1 wkręt,

Format

A4

Skala

1:1

Nr produktu

KMp 14-2



MASZCZYK[®]

Krzysztof Maszczyk
05-071 Sulejówek-Miłosna
ul. Mickiewicza 10

tel.: (022)783 45 20, fax.: (022)783 90 85
kom: 0602 726 086