

PRZEKRÓJ A-A



Tolerancja wymiarowa $\pm 0,5$ mm

Elementy składowe:
- korpus
- pokrywa

Format A4	Skala 1:1
Nr produktu KM-59	



MASZCZYK[®]

OBUDOWY DLA ELEKTRONIKI

„MASZCZYK”
05-071 Sulejówek-Miłosna
ul. Mickiewicza 10

tel: (22) 783-45-20 kom: 602-726-086

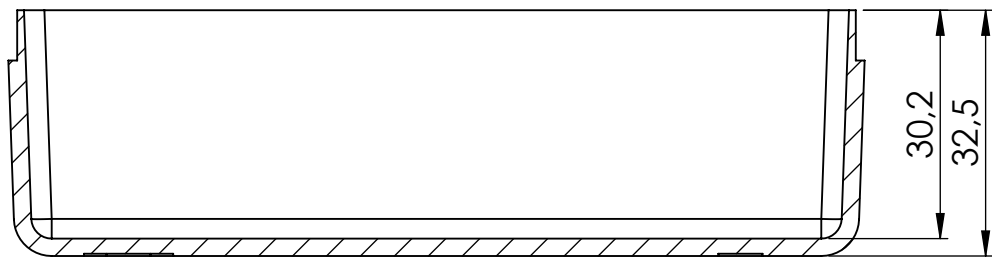
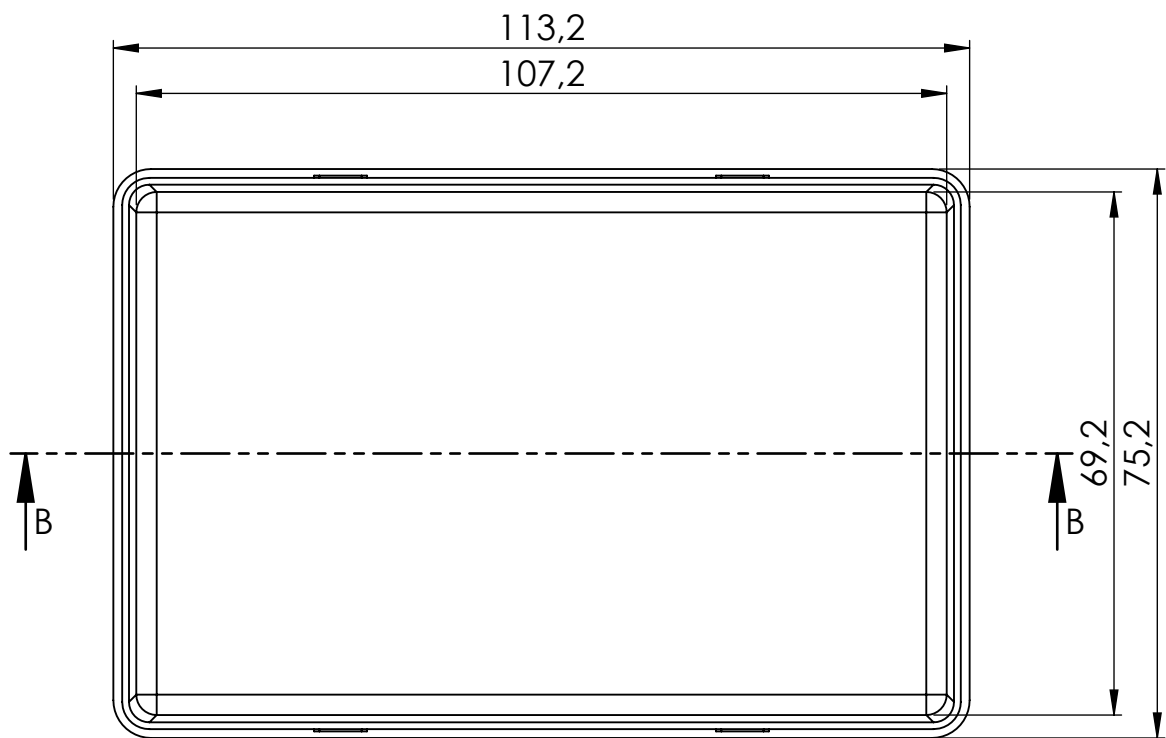

PRZEKRÓJ B-B

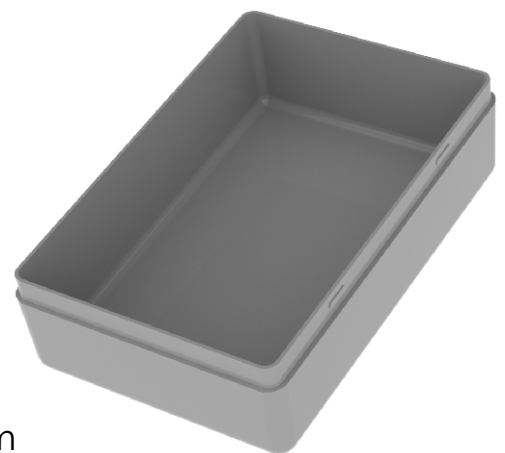

Tolerancja wymiarowa $\pm 0,5$ mm

Format A4	Skala 1:1	 MASZCZYK [®] OBUDOWY DLA ELEKTRONIKI „MASZCZYK” 05-071 Sulejówek-Miłosna ul. Mickiewicza 10 tel: (22) 783-45-20 kom: 602-726-086
Nr produktu KM-59 (korpus)		

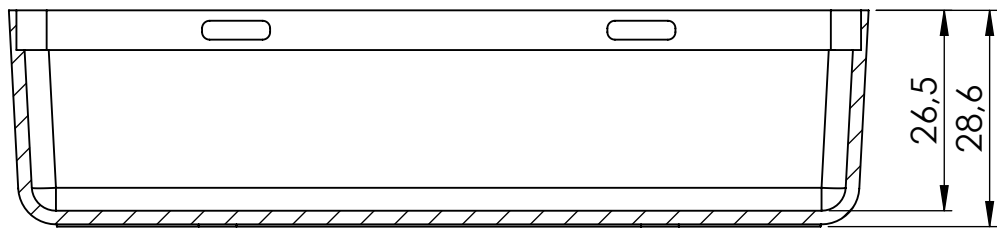
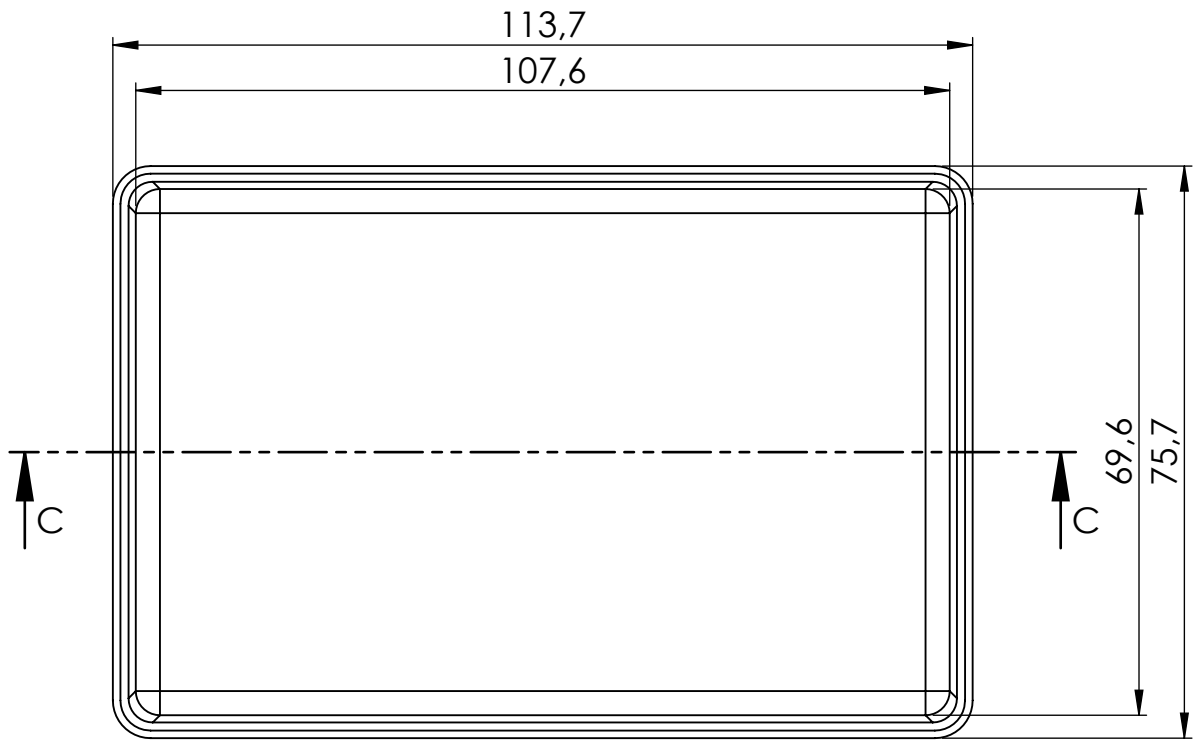

PRZEKRÓJ C-C



Tolerancja wymiarowa $\pm 0,5$ mm

Format A4	Skala 1:1
Nr produktu KM-59 (pokrywa)	



MASZCZYK[®]

OBUDOWY DLA ELEKTRONIKI

„MASZCZYK”

05-071 Sulejówek-Miłosna

ul. Mickiewicza 10

tel: (22) 783-45-20 kom: 602-726-086