

PRZEKRÓJ B-B

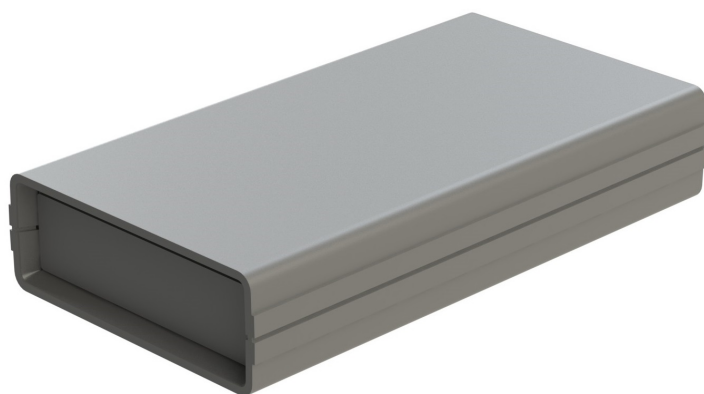

Tolerancja wymiarowa $\pm 0,5$ mm

Elementy składowe:

- pokrywa
- podstawa
- 2x panel
- 4x wkręt

Format	A4	Skala	1:2
Nr produktu	KM-131		



„MASZCZYK”
 05-071 Sulejówek-Miłosna
 ul. Mickiewicza 10
 tel: (22) 783-45-20 kom: 602-726-086

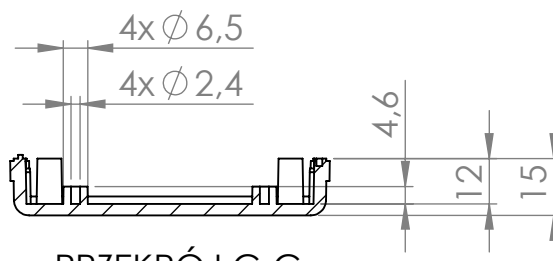
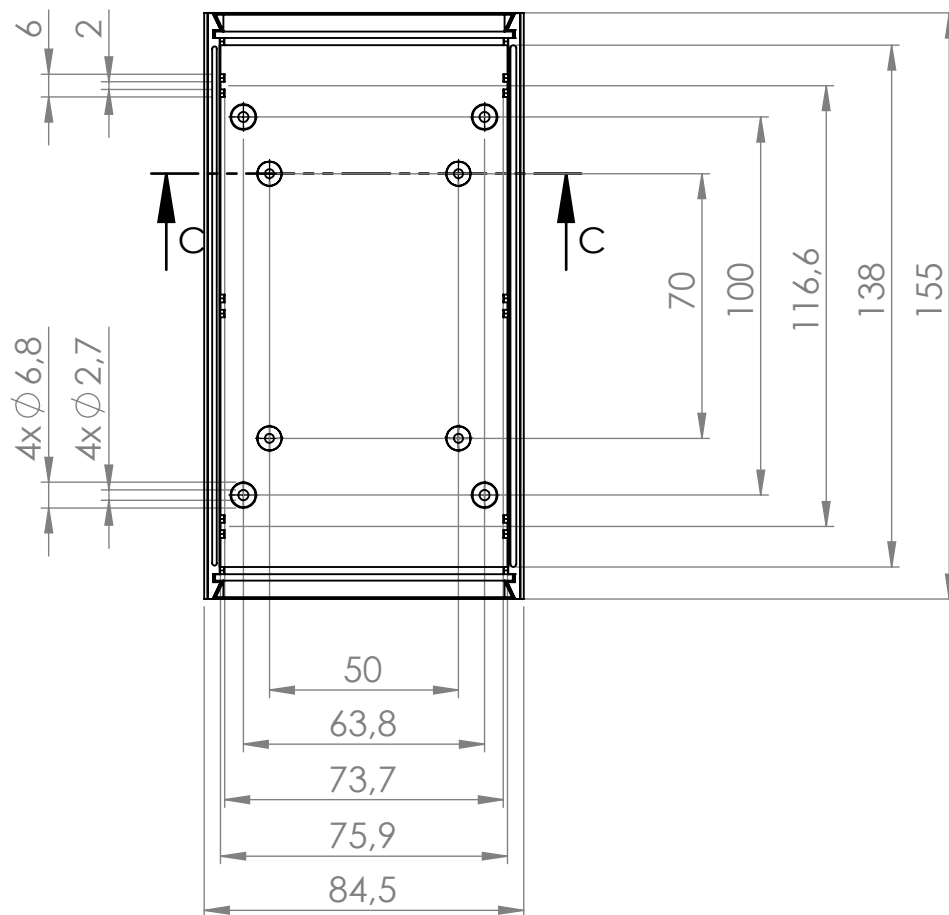

PRZEKRÓJ C-C

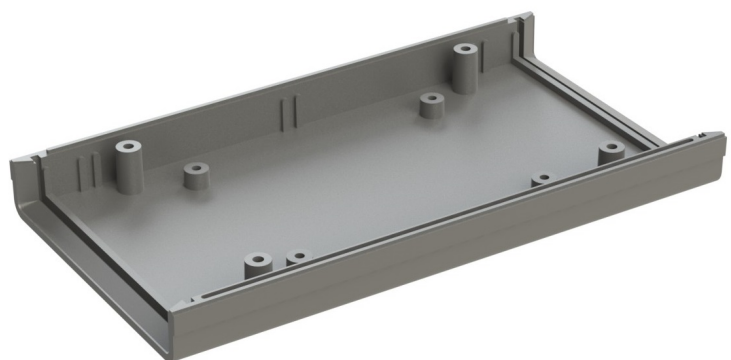

Tolerancja wymiarowa $\pm 0,5$ mm

Format A4	Skala 1:2
Nr produktu KM-131 (pokrywa)	



„MASZCZYK”
05-071 Sulejówek-Miłosna
ul. Mickiewicza 10
tel: (22) 783-45-20 kom: 602-726-086

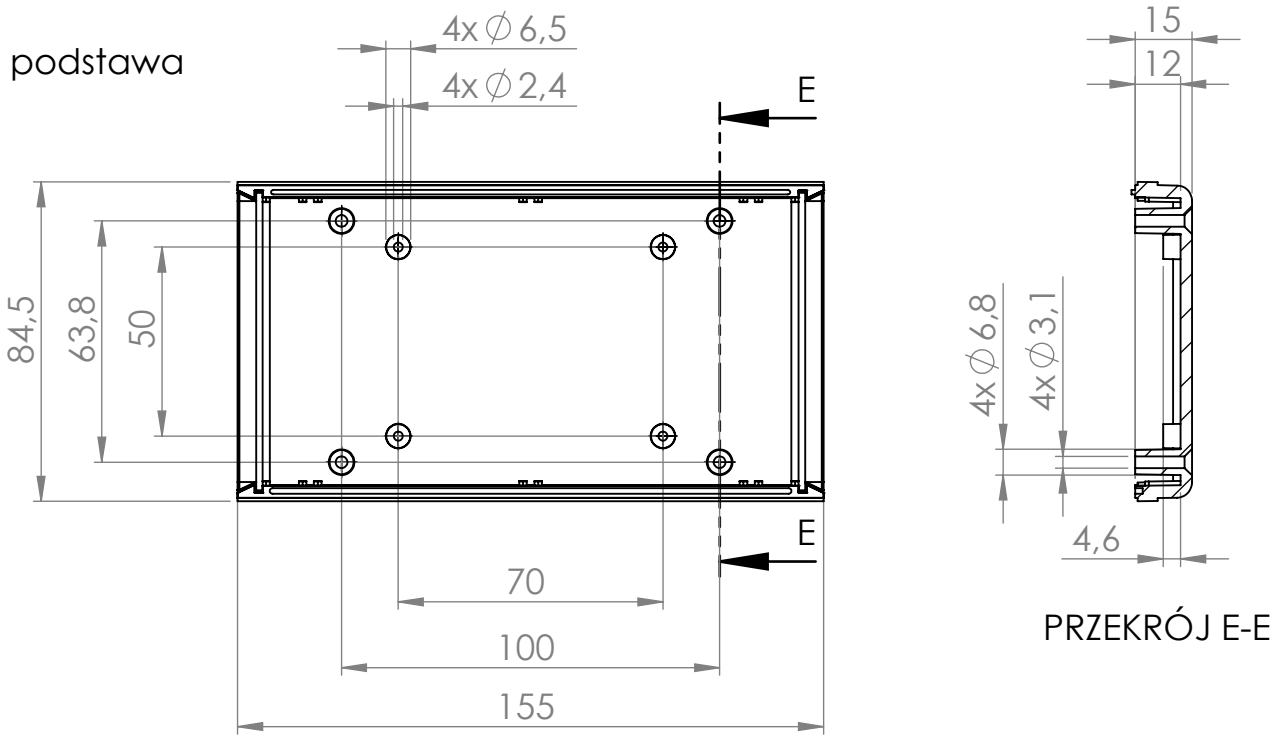

panel

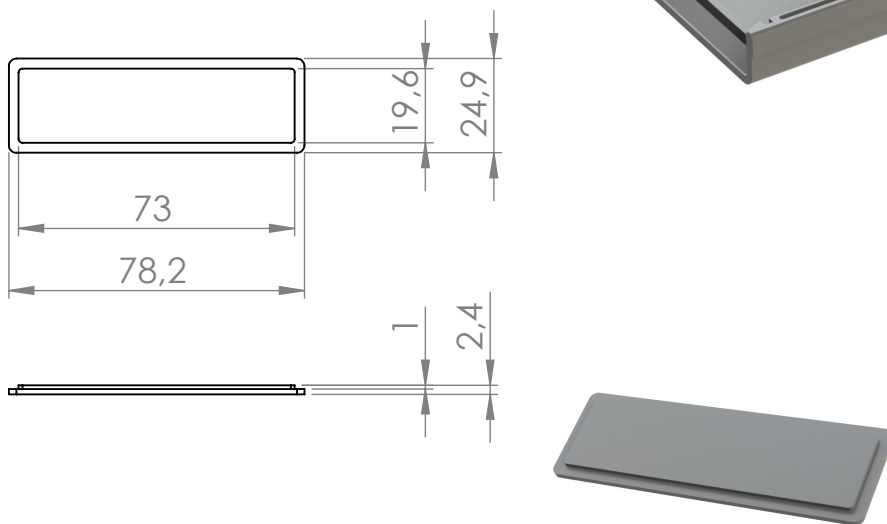

Tolerancja wymiarowa $\pm 0,5$ mm

Format A4	Skala 1:2
Nr produktu KM-131	



„MASZCZYK”
05-071 Sulejówek-Miłosna
ul. Mickiewicza 10
tel: (22) 783-45-20 kom: 602-726-086