

Góra:

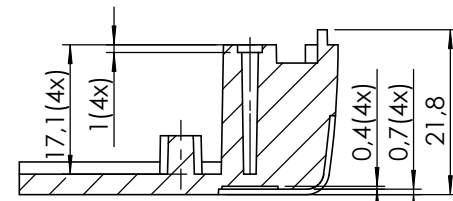

PRZEKRÓJ A-A  
SKALA 1 : 1

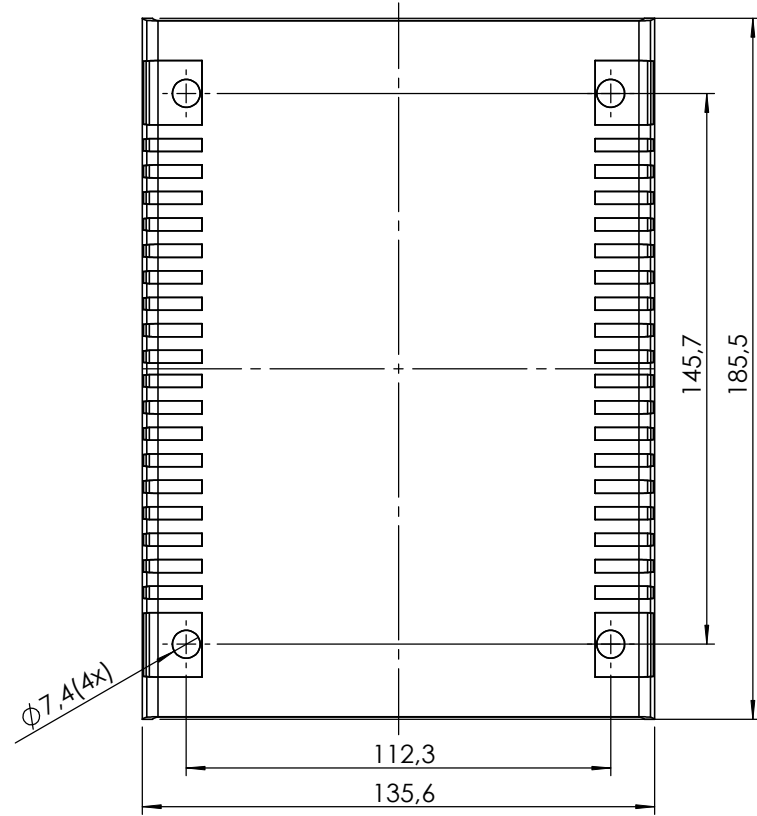
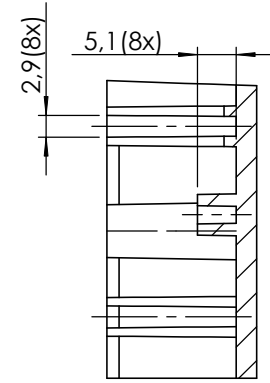

PRZEKRÓJ B-B  
SKALA 1 : 1

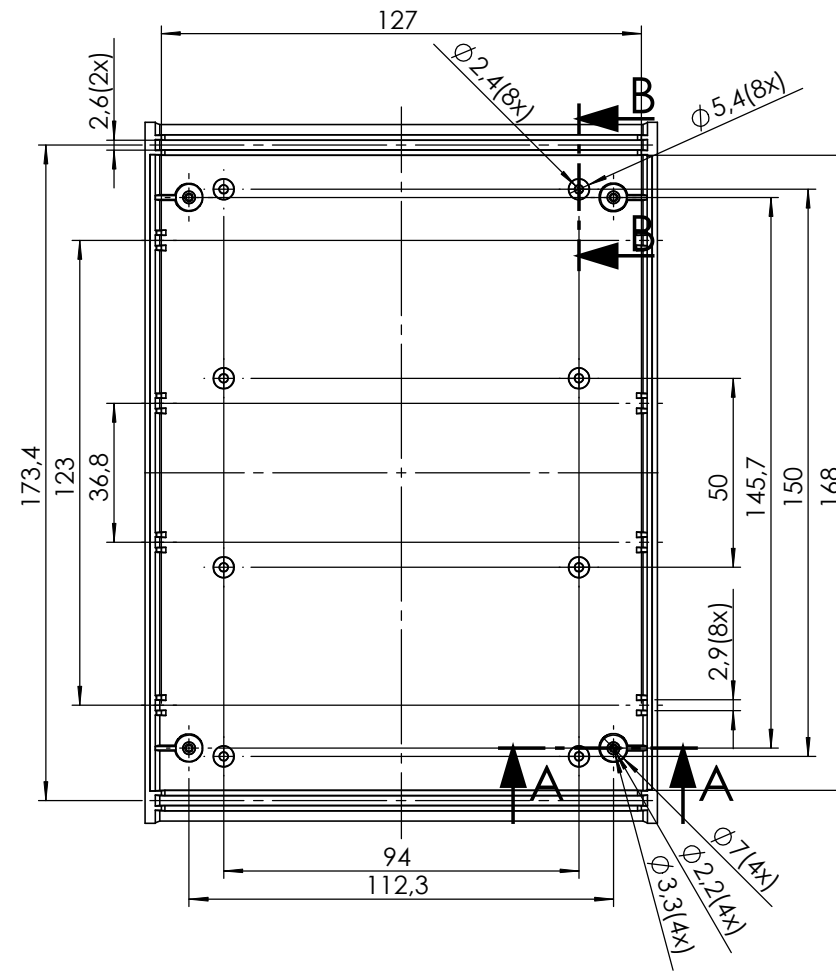

Klapka:

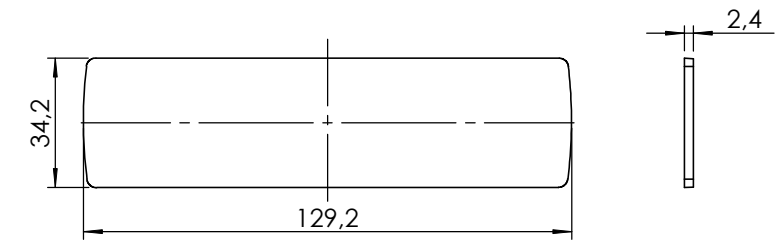

Stopka:

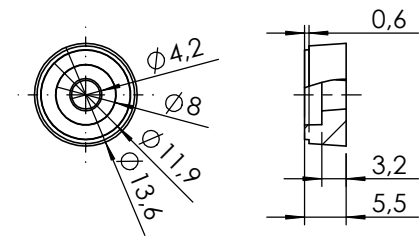

Dół:

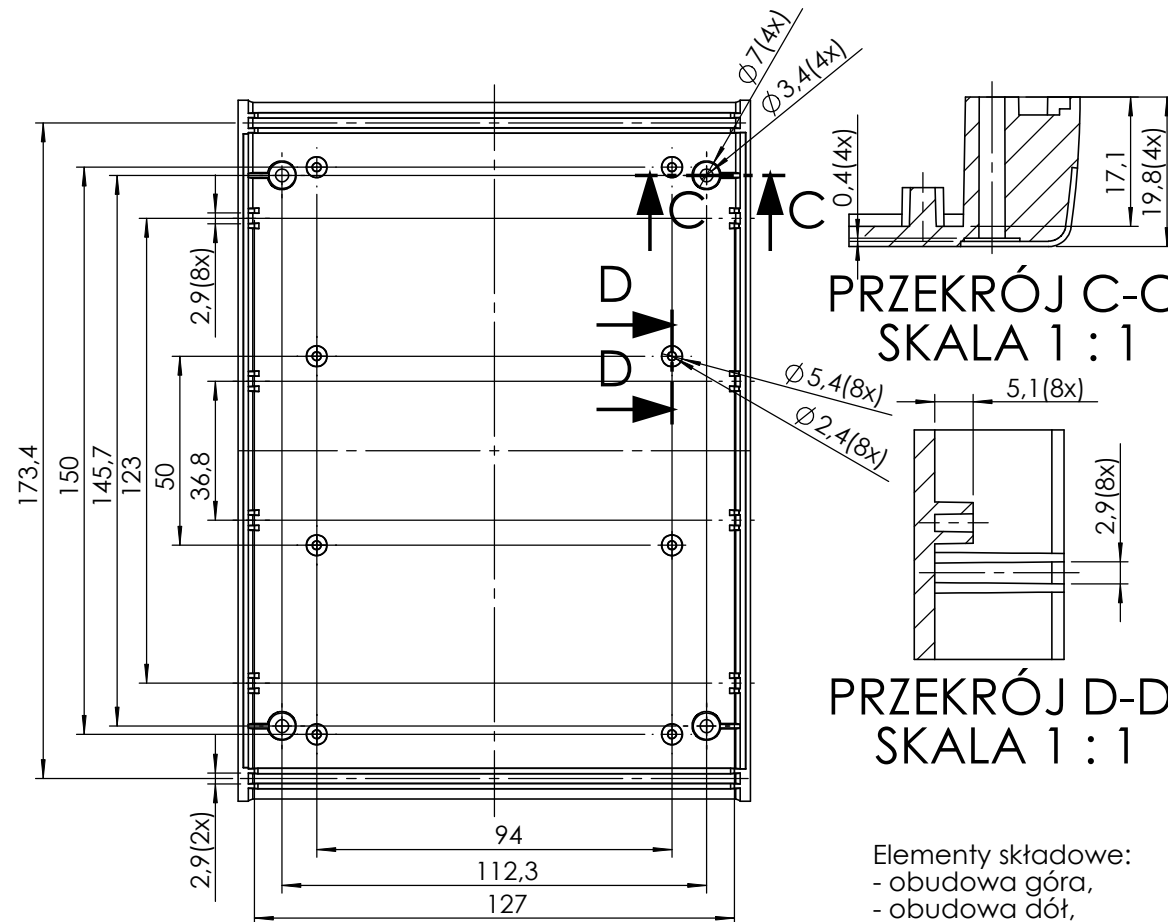
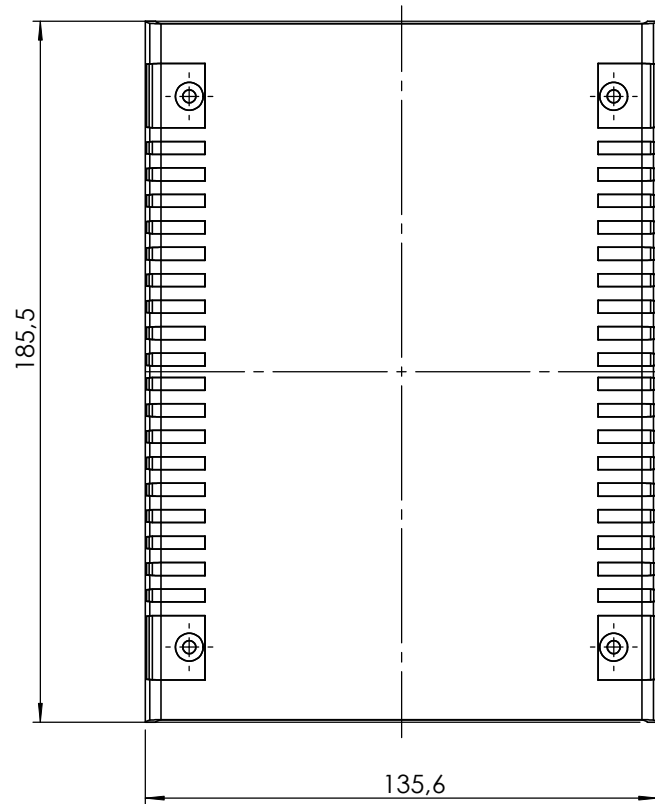

PRZEKRÓJ C-C  
SKALA 1 : 1

PRZEKRÓJ D-D  
SKALA 1 : 1

- Elementy składowe:
- obudowa góra,
  - obudowa dół,
  - 2x klapka,
  - 4x stopka,
  - 4x wkręt,

maxPCB: 104mm x 166mm

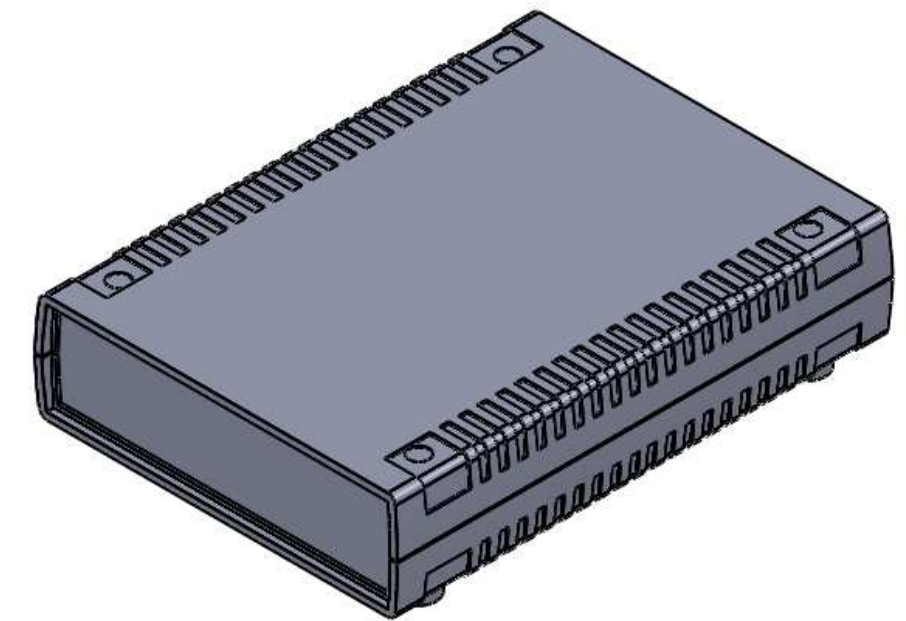

UWAGA: Wymiary w tolerancji  $\pm 0,5$ mm

Format	Skala
A3	1:2
Nr produktu	
Z-112A	



Krzysztof Maszczyk  
05-071 Sulejówek-Mitosa  
ul. Mickiewicza 10  
tel.: (022)783 45 20, fax.: (022)783 90 85  
kom: 0602 726 086