

Góra:

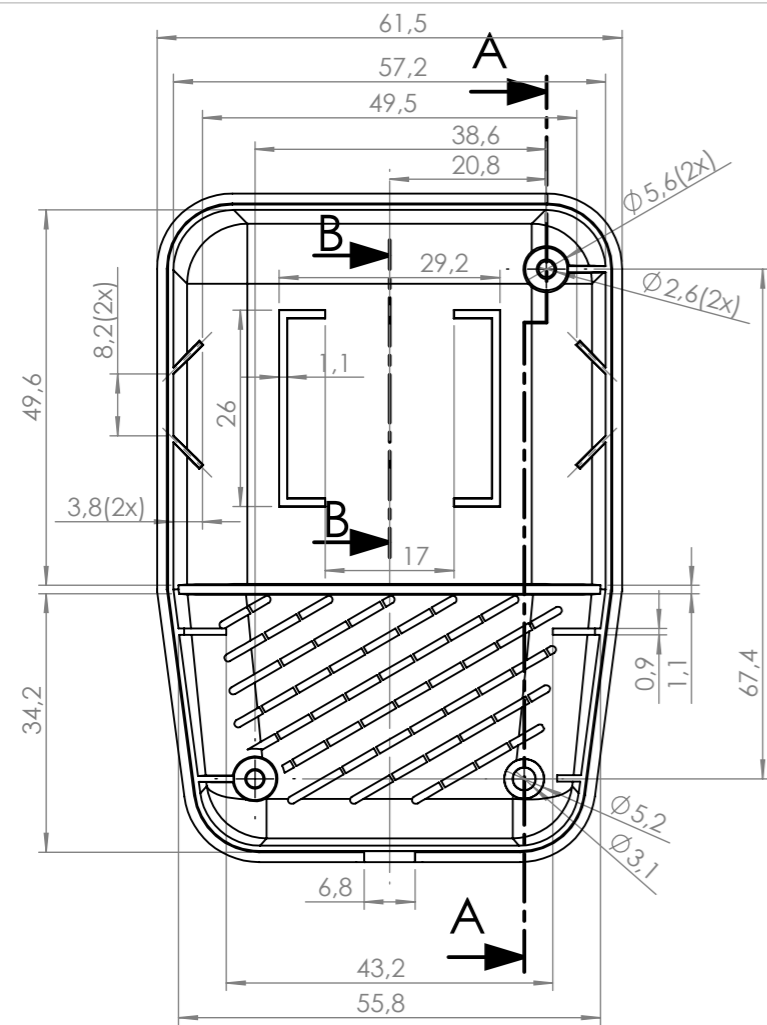

Dół:

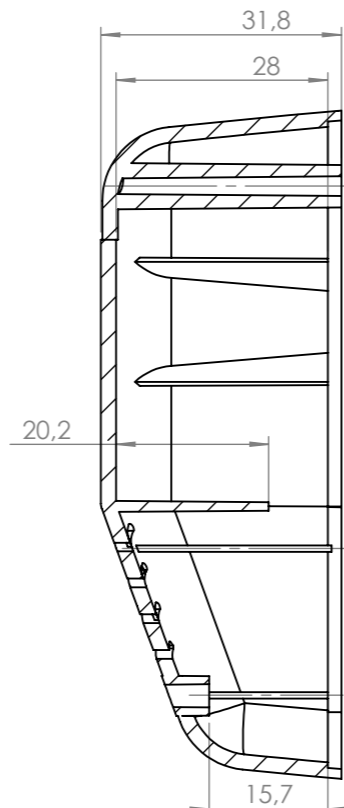
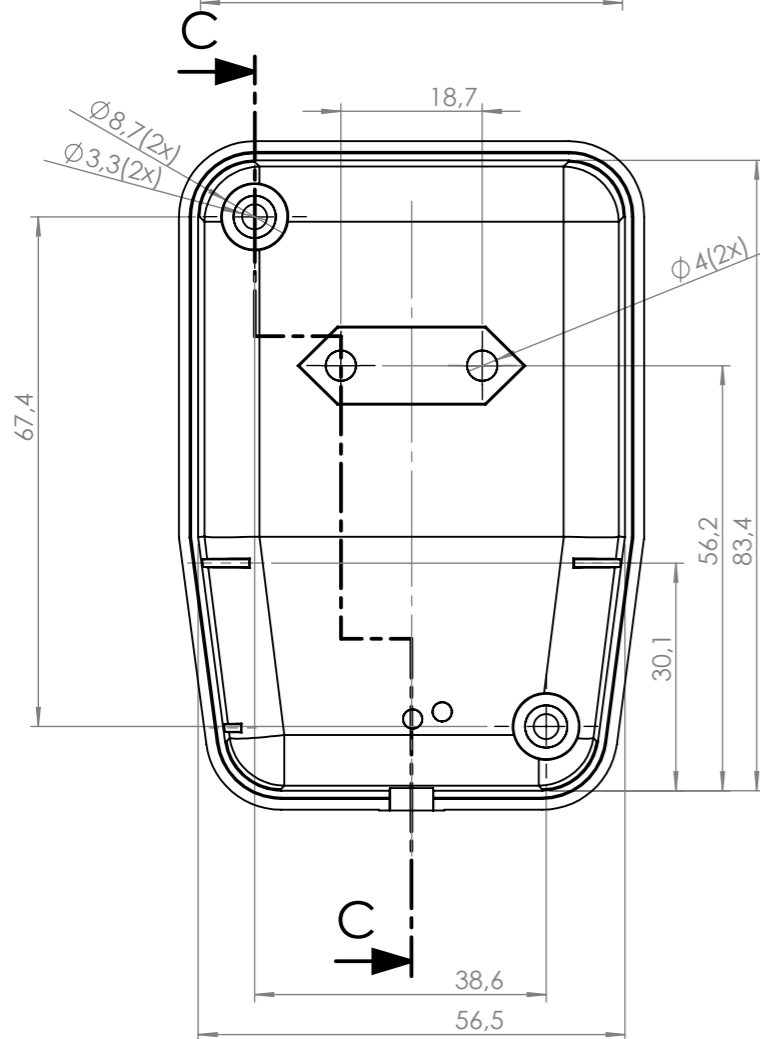

PRZEKRÓJ A-A
SKALA 1 : 1

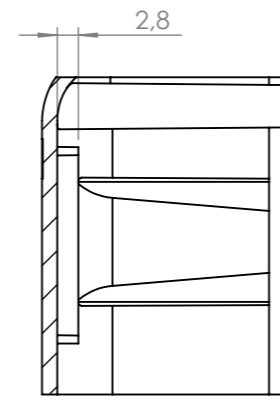

PRZEKRÓJ B-B
SKALA 1 : 1

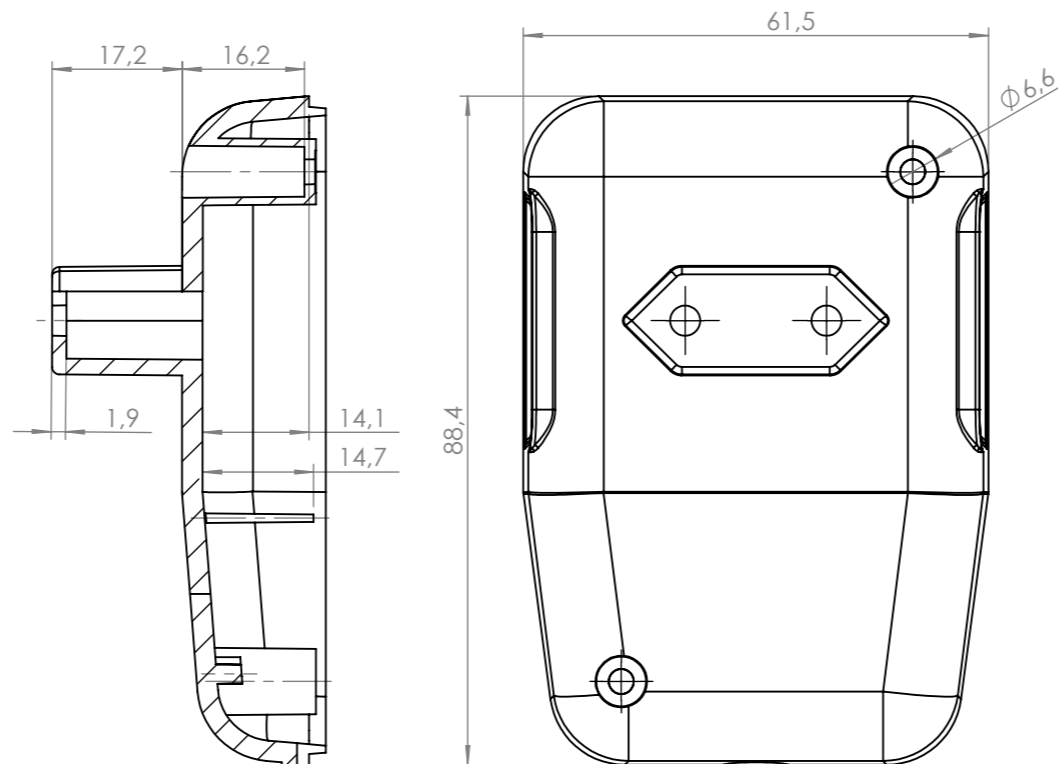
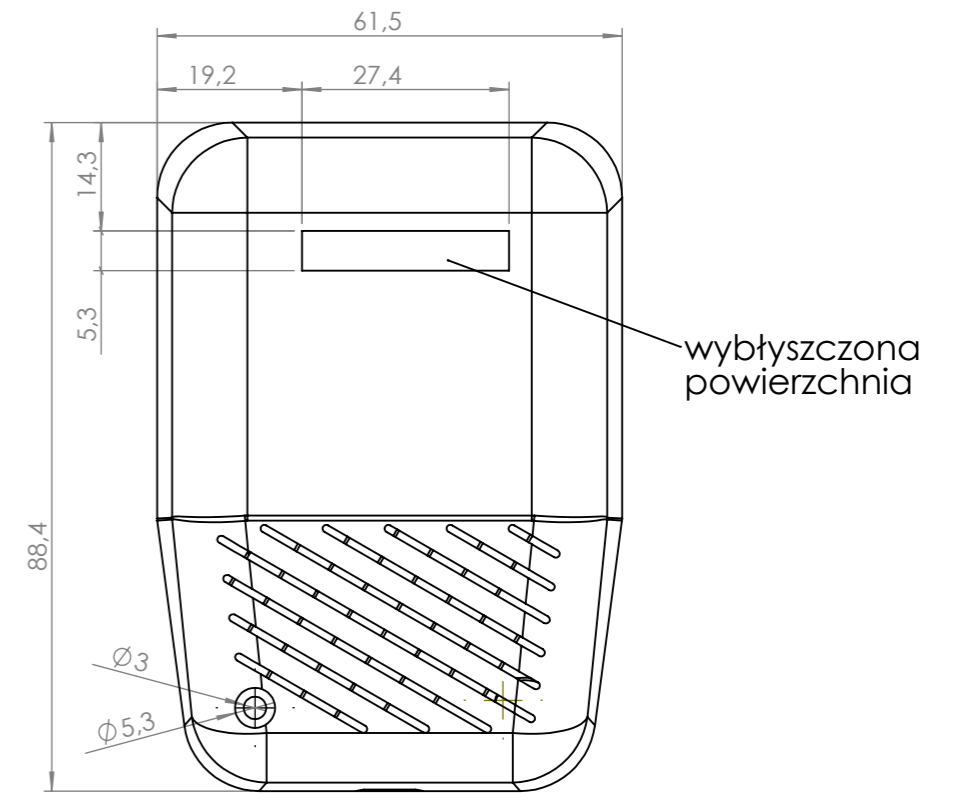

PRZEKRÓJ C-C
SKALA 1 : 1

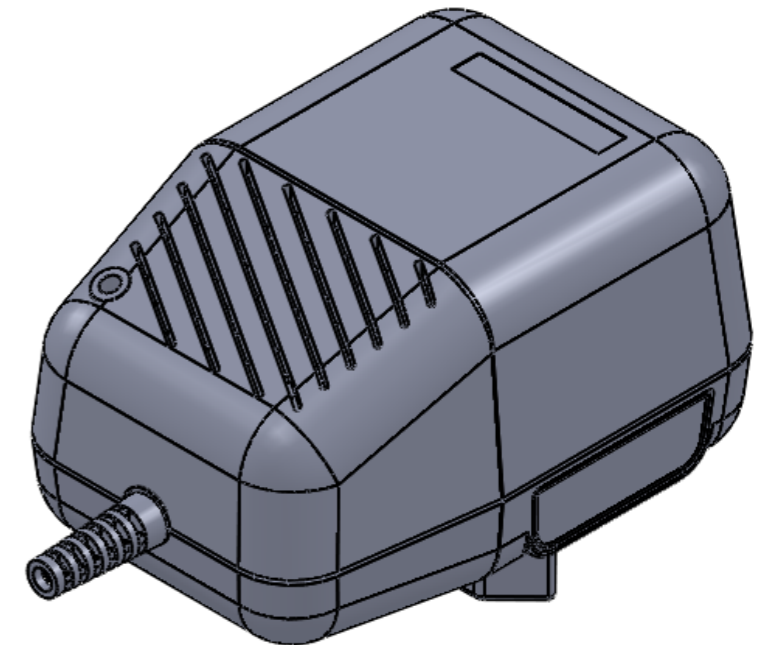

- Elementy składowe:
- obudowa góra,
 - obudowa dół,
 - bolce,
 - odgiętka,
 - wkręt 2x,

maxPCB: 53mm x 20mm

UWAGA: Wymiary w tolerancji $\pm 0,5\text{mm}$

Format	Skala
A3	1:1

Nr produktu

KM-402



Maszczyk
05-071 Sulejówek-Miłosna
ul. Mickiewicza 10
tel.: (022)783 45 20, fax.: (022)783 90 85
kom: 0602 726 086